

Metal enclosure Position switches Metal MN78

NEW

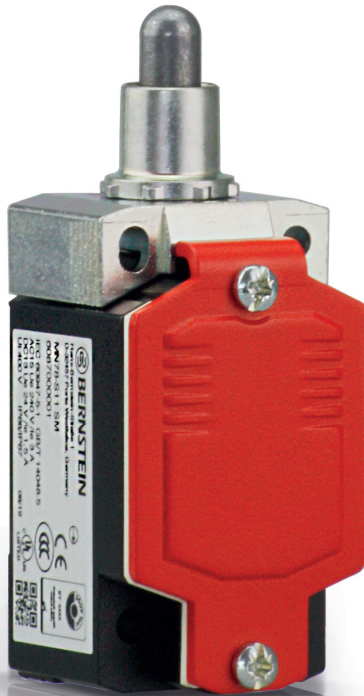

2 OR 4 CONTACTS

Product characteristics

- Standard switch according to DIN EN 50041, standard actuator according to DIN EN 50041
- Protection class IP66 and IP67 conforming to EN 60529
- Enclosure: Die-cast aluminium
- Cover: Aluminium
- Actuator rotatable by $8 \times 45^\circ$
- Cable entry M20 \times 1.5

Good to know ...

The MN78 is the metal version of the IN73 and designed for the use in very rough environments. A modular, robust metal enclosure with a wide range of Metalast actuators. Just as with the IN73, the MN78 offers additional fixing holes for safe installation.

It can be equipped with the C14 or C17 switch insert (2 contacts or 4 contacts).

Rough environments, outdoor areas, or high mechanical loads are all no problem for the MN78.

Technical design

- Slow- and snap action
- **Versions:**
 With C14 switch insert: 2 NC, 2 NO, 1 NC/1 NO
 With C17 switch insert: 4 NO, 4 NC, 2 NO/2 NC
 1 NC/3 NO and 3 NC/1 NO

Technical data

Electrical data		
Design insulation voltage	U_i max.	400 V AC
Conventional thermoelectric current	(up to) I_{the}	5 A
Rated operating voltage	U_e max.	240 V AC / 24 V DC
Utilisation category (up to)		AC-15, U_e/I_e 240 V/3 A DC-13 U_e/I_e 24 V/1.5 A (B300 Table A.1)
Short circuit protection (up to)		Safety fuse 4 A gG
Protection class		II, protective insulation
Mechanical data		
Enclosure material		Metal, glass-fibre reinforced (UL 94-V0)
Ambient temperature		-30 °C to +75 °C
Mechanical lifetime (up to)		30 × 10 ⁶ switching cycles
B10d NC Contact cycles (up to)		20 million
B10d NO Contact cycles (up to)		1 million
Switching frequency		≤ 60/min.
Type of connection		4 screwed connections (M3)
Conductor cross-sections		Single-wire 0.5 – 1.5 mm ² or strand with wire-end ferrule 0.5 – 1.5 mm ²
Cable entry		1 × M20 × 1.5
Protection class		IP66/IP67 according to EN 60529; DIN VDE 0470 T1
Standards		
VDE 0660 T211, DIN EN 60947-5-4, IEC 60947-5-4 DIN EN ISO 13849-1, DIN EN ISO 13849-2		
① Depending on switching system		

Options

- Available with M12 connector
- Customised cables and connectors are available on request

Mounting

- 2 screws M5, adjustment with oval holes
- 2 screws M5 for safety applications without additional fixation required

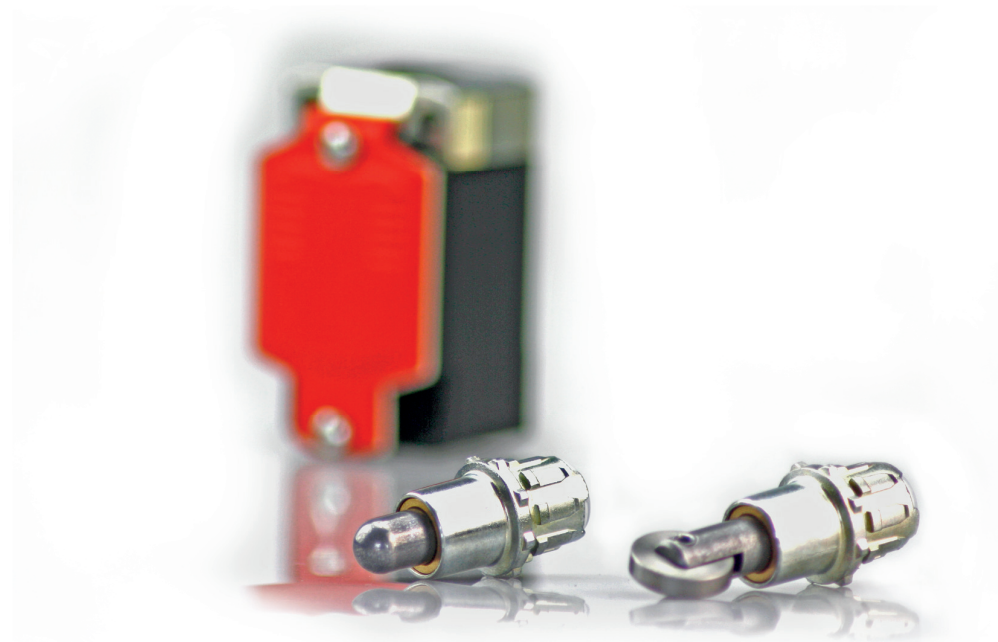

POSITION SWITCHES METAL MN78

MN78-... SM

Replacement actuator: 3918022415

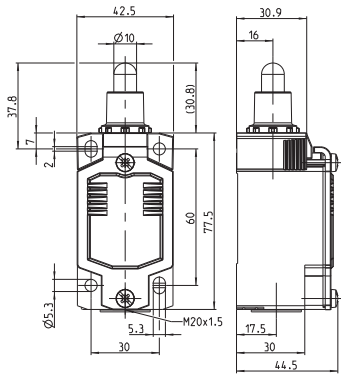

	1 NC / 1 NO	2 NC	2 NO	2 NC / 2 NO
--	-------------	------	------	-------------

Slow-action system

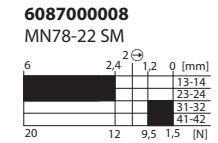
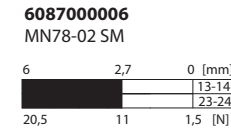
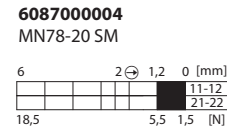
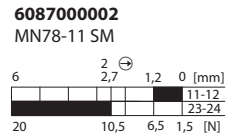

Snap-action system

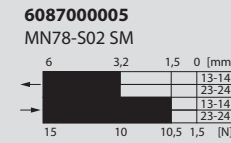
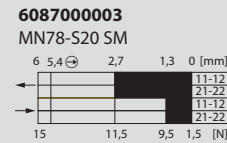
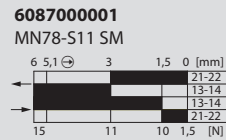

	4 NC	4 NO	3 NC / 1 NO	1 NC / 3 NO	1 NC / 1 NO overlapping
--	------	------	-------------	-------------	-------------------------

Slow-action system

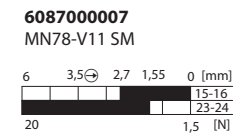
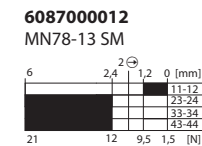
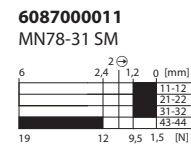
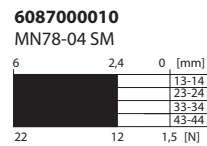
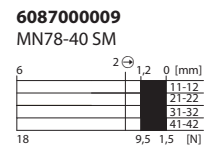

Replacement actuator: 3918172417

MN78-... RM

	1 NC / 1 NO	2 NC	2 NO	2 NC / 2 NO
--	-------------	------	------	-------------

Slow-action system

608700014
MN78-11 RM

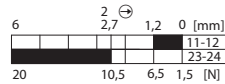

608700016
MN78-20 RM

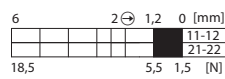

608700018
MN78-02 RM

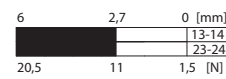

608700020
MN78-22 RM

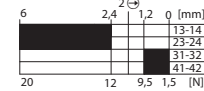

Snap-action system

608700013
MN78-S11 RM



608700015
MN78-S20 RM

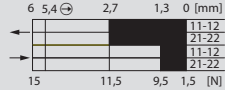

608700017
MN78-S02 RM

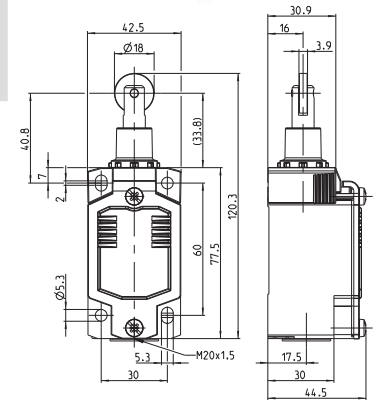
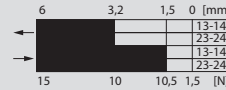

	4 NC	4 NO	3 NC / 1 NO	1 NC / 3 NO	1 NC / 1 NO overlapping
--	------	------	-------------	-------------	-------------------------

Slow-action system

608700021
MN78-40 RM

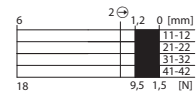

608700022
MN78-04 RM

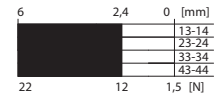

608700023
MN78-31 RM

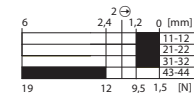

608700024
MN78-13 RM

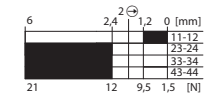

608700019
MN78-V11 RM

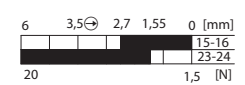

POSITION SWITCHES METAL MN78

MN78-... HK

Replacement actuator: 3918202432

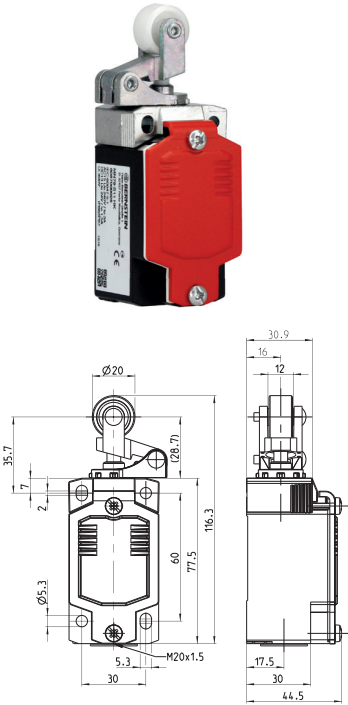

	1 NC / 1 NO	2 NC	2 NO	2 NC / 2 NO
--	-------------	------	------	-------------

Slow-action system

6087000026
MN78-11 HK

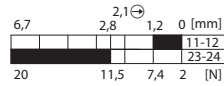

6087000028
MN78-20 HK

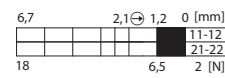

6087000030
MN78-02 HK

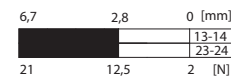

6087000032
MN78-22 HK

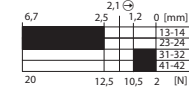

Snap-action system

6087000025
MN78-S11 HK

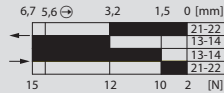

6087000027
MN78-S20 HK

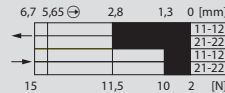

6087000029
MN78-S02 HK



	4 NC	4 NO	3 NC / 1 NO	1 NC / 3 NO	1 NC / 1 NO overlapping
--	------	------	-------------	-------------	-------------------------

Slow-action system

6087000033
MN78-40 HK

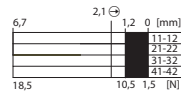

6087000034
MN78-04 HK

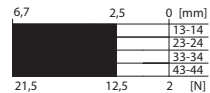

6087000035
MN78-31 HK

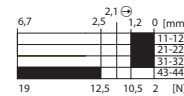

6087000036
MN78-13 HK

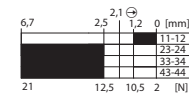

6087000031
MN78-V11 HK

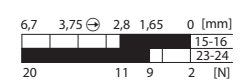



Replacement actuator: 3918202428

MN78-... DGHK

	1 NC / 1 NO	2 NC	2 NO	2 NC / 2 NO
Slow-action system	6087000038 MN78-11 DGHK 	6087000040 MN78-20 DGHK 	6087000042 MN78-02 DGHK 	6087000044 MN78-22 DGHK
Snap-action system	6087000037 MN78-S11 DGHK 	6087000039 MN78-S20 DGHK 	6087000041 MN78-S02 DGHK 	

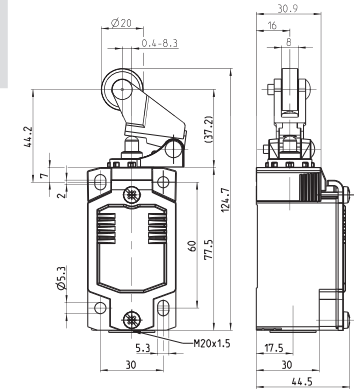

	4 NC	4 NO	3 NC / 1 NO	1 NC / 3 NO	1 NC / 1 NO overlapping
Slow-action system	6087000045 MN78-40 DGHK 	6087000046 MN78-04 DGHK 	6087000047 MN78-31 DGHK 	6087000048 MN78-13 DGHK 	6087000043 MN78-V11 DGHK

POSITION SWITCHES METAL MN78

MN78-... DGKK

Replacement actuator: 3918202430

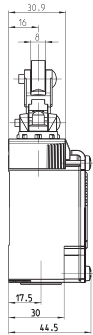
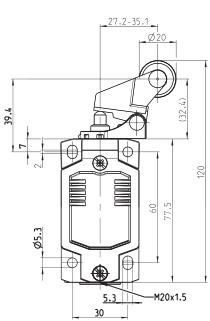
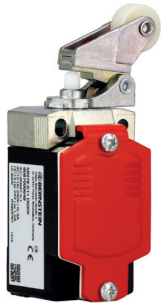

	1 NC / 1 NO	2 NC	2 NO	2 NC / 2 NO
--	-------------	------	------	-------------

Slow-action system

6087000050
MN78-11 DGKK

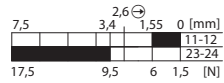

6087000052
MN78-20 DGKK

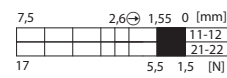

6087000054
MN78-02 DGKK

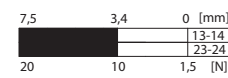

6087000056
MN78-22 DGKK

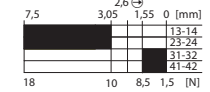

Snap-action system

6087000049
MN78-S11 DGKK

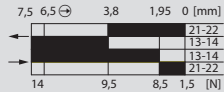

6087000051
MN78-S20 DGKK

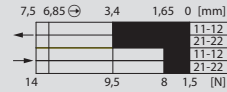

6087000053
MN78-S02 DGKK

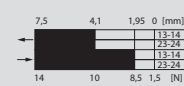

	4 NC	4 NO	3 NC / 1 NO	1 NC / 3 NO	1 NC / 1 NO overlapping
--	------	------	-------------	-------------	-------------------------

Slow-action system

6087000057
MN78-40 DGKK

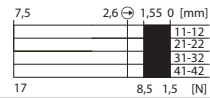

6087000058
MN78-04 DGKK

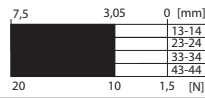

6087000059
MN78-31 DGKK

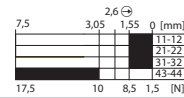

6087000060
MN78-13 DGKK

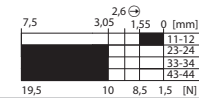

6087000055
MN78-V11 DGKK

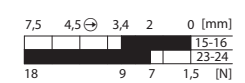



Replacement actuator: 3918352393

MN78-... AHK

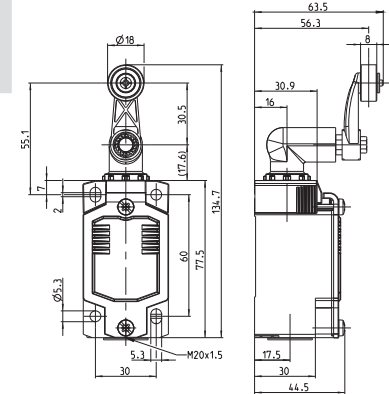

	1 NC / 1 NO	2 NC	2 NO	2 NC / 2 NO
--	-------------	------	------	-------------

Slow-action system

608700062
MN78-11 AHK

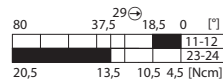

608700064
MN78-20 AHK

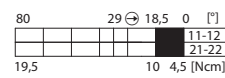

608700066
MN78-02 AHK

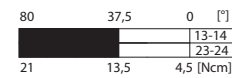

608700068
MN78-22 AHK

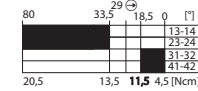

Snap-action system

608700061
MN78-S11 AHK

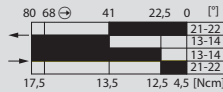

608700063
MN78-S20 AHK

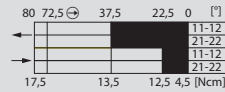

608700065
MN78-S02 AHK

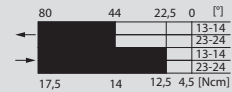

	4 NC	4 NO	3 NC / 1 NO	1 NC / 3 NO	1 NC / 1 NO overlapping
--	------	------	-------------	-------------	-------------------------

Slow-action system

608700069
MN78-40 AHK

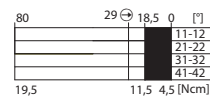

608700070
MN78-04 AHK

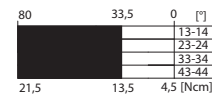

608700071
MN78-31 AHK

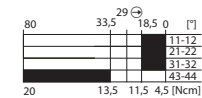

608700072
MN78-13 AHK

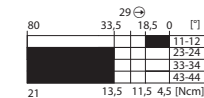

608700067
MN78-V11 AHK

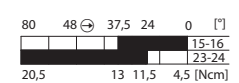

POSITION SWITCHES METAL MN78

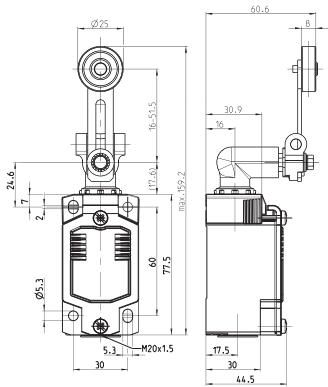

MN78-... AVK

Replacement actuator: 3918362424



	1 NC / 1 NO	2 NC	2 NO	2 NC / 2 NO
--	-------------	------	------	-------------

Slow-action system

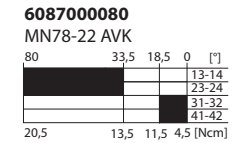
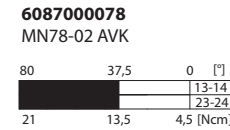
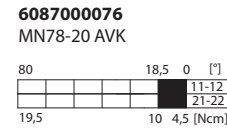
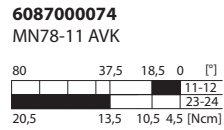

Snap-action system

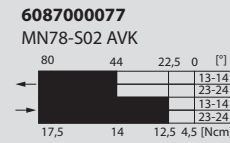
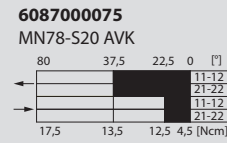
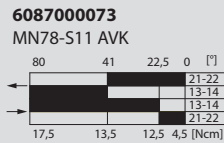

	4 NC	4 NO	3 NC / 1 NO	1 NC / 3 NO	1 NC / 1 NO overlapping
--	------	------	-------------	-------------	-------------------------

Slow-action system

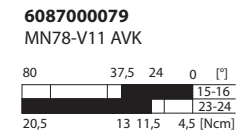
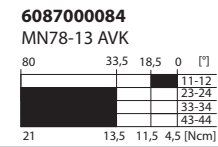
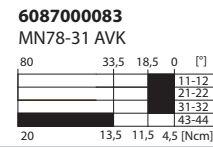
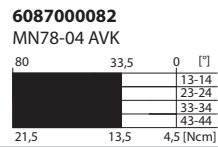
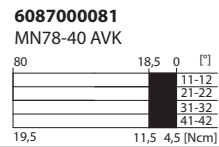



Replacement actuator: 3918372421

MN78-... AHDM

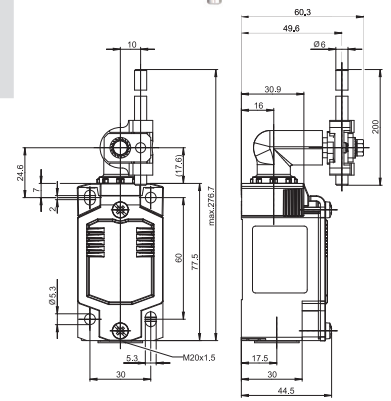

	1 NC / 1 NO	2 NC	2 NO	2 NC / 2 NO
--	-------------	------	------	-------------

Slow-action system

608700086
MN78-11 AHDM

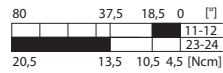

608700088
MN78-20 AHDM

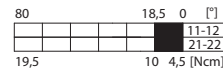

608700090
MN78-02 AHDM

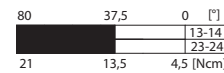

608700092
MN78-22 AHDM

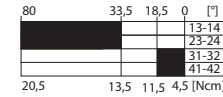

Snap-action system

608700085
MN78-S11 AHDM

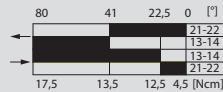

608700087
MN78-S20 AHDM

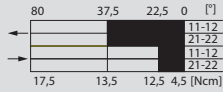

608700089
MN78-S02 AHDM

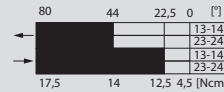

	4 NC	4 NO	3 NC / 1 NO	1 NC / 3 NO	1 NC / 1 NO overlapping
--	------	------	-------------	-------------	-------------------------

Slow-action system

608700093
MN78-40 AHDM

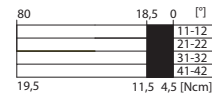

608700094
MN78-04 AHDM

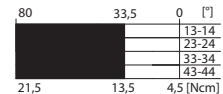

608700095
MN78-31 AHDM

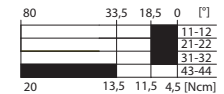

608700096
MN78-13 AHDM

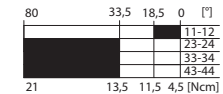

608700091
MN78-V11 AHDM

